

Glydea™ Range EXPANDING HORIZONS



GLYDEA™ INSTALLATION AND PROGRAMMING INSTRUCTIONS



Glydea™

Installation Guide 1/4

MANDATORY SAFETY INSTRUCTIONS

For Glydea™ actuators intended for fabric curtain tracks installed horizontally, and for indoor use only. Any use outside the scope of application specified by SOMFY is non-compliant. SOMFY cannot be held liable for any such use or failure to observe these instructions, which will also result in warranty being voided. Should any doubt arise during installation of the motor or in order to obtain additional information, please visit the www.Somfy.com website or refer to your SOMFY contact (see branch details printed on this document).

IMPORTANT SAFETY INSTRUCTIONS FOR INSTALLATION

WARNING: improper installation may result in serious injury. Follow the installation instructions in full, as well as those shown in the enclosed user leaflet.

To be handed to the user.

The motor must be installed by an installer who is qualified in motorized systems and domestic automation.

The installer must inform the user of the need to arrange maintenance for the motorized unit and its associated accessories. He must specify items that require maintenance, replacement or checking. The torque, operating time and speed of the SOMFY actuator must be compatible with the specifications of the motorized unit: your SOMFY contact will provide a method of selecting motors for each application.

-Use only accessories (Curtain track, brackets, etc.) listed by SOMFY to fit to a unit. Part numbers for accessories are available from your SOMFY contact.

-Please refer to the SOMFY literature to ascertain the control points) compatible with the actuator selected.

-In areas subject to frequent power cuts it will be necessary to install an emergency facility or backup power supply.

-Fit control devices in visible positions.

-A multi-pole switching device must be provided further up the power supply, i.e. a device which electrically isolates each active conductor simultaneously (minimum contact opening gap: 3.5 mm).

-Protect cables routed through a wall with an insulated cable bushing.

-If the cable or the power supply connector is damaged, return the actuator to the service department to avoid any risk.

-Secure the cables to prevent any contact with moving parts.

-Leave the power supply cable to the actuator accessible: it must be easily replaceable.

-To reduce the risk of electric shock, this equipment must have a proper grounding. Some Motors versions are supplied with a grounding type plug, that has a third (grounding) pin. This plug will only fit into a grounding type outlet. If the plug does not fit into the outlet, contact a qualified electrician to install the proper outlet. Do not change the plug in any way.

- A Motorized curtain track installation, equipped with two Glydea 60e motors, will be deemed safe if at least one of the following conditions is met (EN 13659 and EN 60 335-2-97)

-The motorized curtain track is controlled by a control point without locking, installed within sight of the closing but away from moving parts and at a height of at least 1.50 m.

-The crush zone is located at a height in excess of 2.50 m from the ground or any permanent access level.

IMPORTANT SAFETY INSTRUCTIONS

WARNING: it is important for everyone's safety to follow these instructions in full.

Keep these instructions for future reference.

-Your installer should inform you of any maintenance required.

-SOMFY recommends the presence of at least one control point close to the motorized unit or group of motorized units.

-Do not allow children to play with fixed control devices. Keep remote controls out of the reach of children.

-Do not use the emergency facility unless there is a mains power cut.

-Keep a watch on the motorized unit while it is moving and ensure that people stay clear until the motorized unit is fully closed.

-Disconnect the actuator from the power supply while maintenance work (e.g. window cleaning) is in progress in the vicinity.

-Check the system frequently in order to detect any out-of-balance condition or signs of wear. Do not use the motorized unit if it needs repair or adjustment.

-This appliance is not intended for use by persons (including children) with reduced physical, sensory or mental capabilities, or lack of experience and knowledge, unless they have been given supervision or instruction concerning use of the appliance by a person responsible for their safety.

-Children should be supervised to ensure that they do not play with the appliance.

Glydea™ Installation Guide 2/4

A) Characteristics

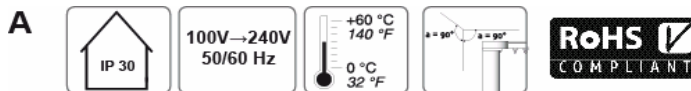

B) Measured

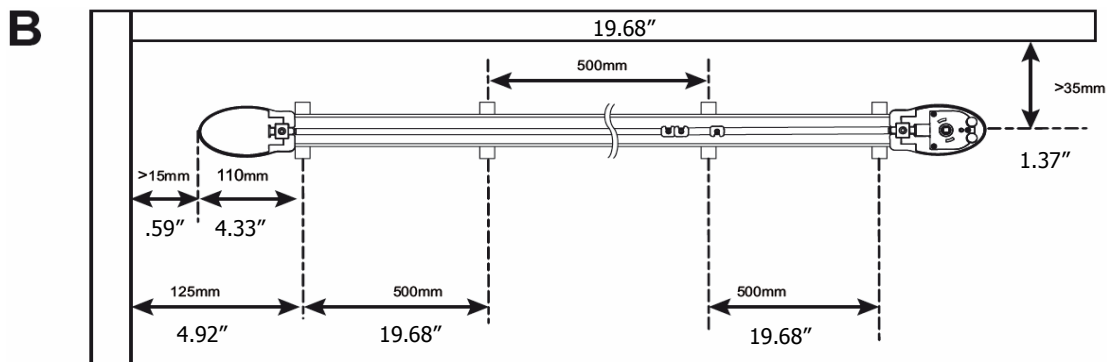

C) Installation of the rail

- [1] Mark the position of the bracket
- [2] Pierce the ceiling or the wall at the right places
- [3] Attach the brackets on it
- [4] Attach the rail on the bracket

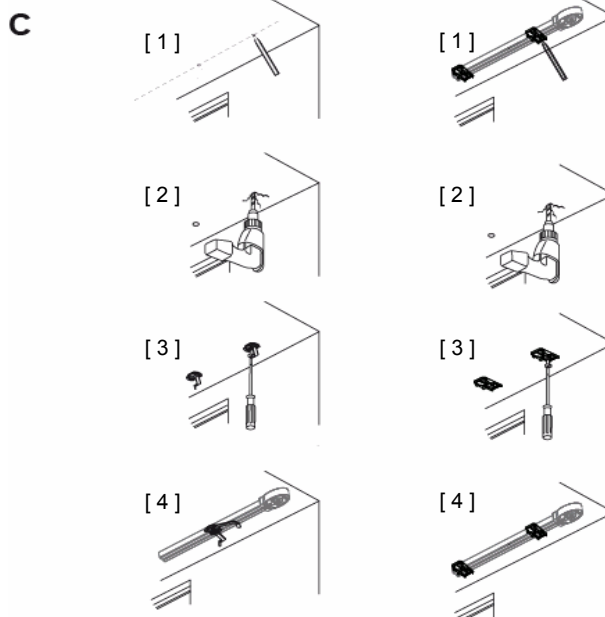

Glydea™ Installation Guide 3/4

D) Power supply

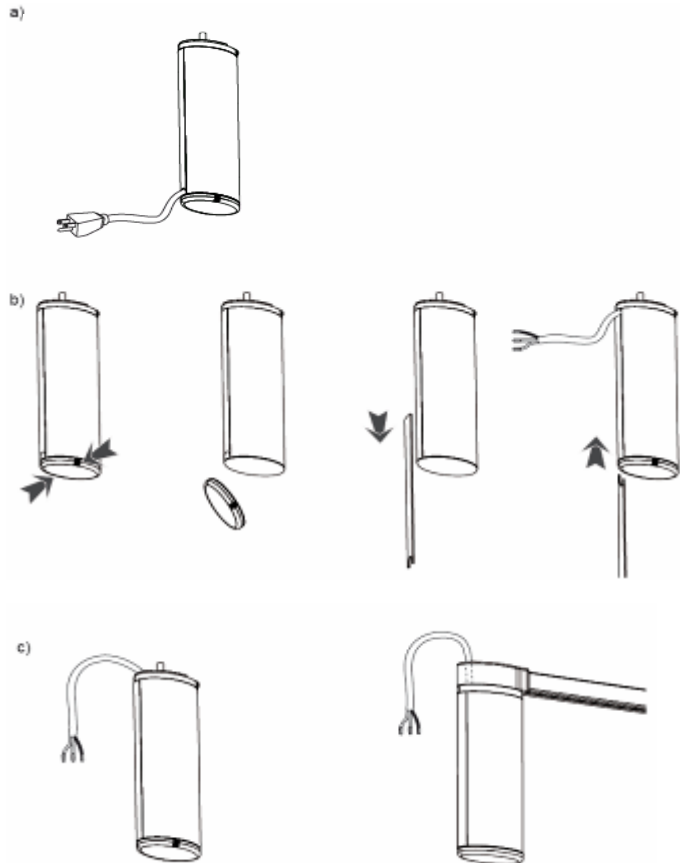

Cable output option:

a) By the bottom of the motor through the notch of the wire cover

b) By the top of the motor through the notch of the wire cover

c) Through the pulley

E) Installation of the motor

- [1] Unlock the motor
- [2] Insert the motor shaft in the drive pulley hole
- [3] Lock the motor



Glydea™

Installation Guide 4/4

F) Wiring of the motor

[1] DCT & RTS motors

Power wiring

2 or 3 NO dry Contact & IR:

1: CCW (Open) NO Dry contact

2: IR OUT

3: Ground Common

4: +5V

5: Stop - NO Dry contact

6: CW (Close) NO Dry contact

7: Optional module socket

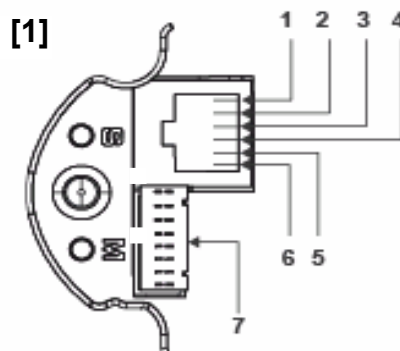

[2] Motors equipped with a US power plug

[2]

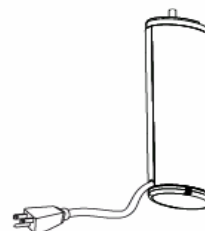

Glydea™ 35 DCT Programming Instructions 1/2

A) Compatible controls And control wiring

- 1) DCT setting tool
- 2) Centralis IB
- 3) 2 NO (Normally Open)
Dry contact switch
- 4) Somfy CS1
- 5) IR8
- 6) IR1
- 7) IR3 & RJ9/RJ12 adapter

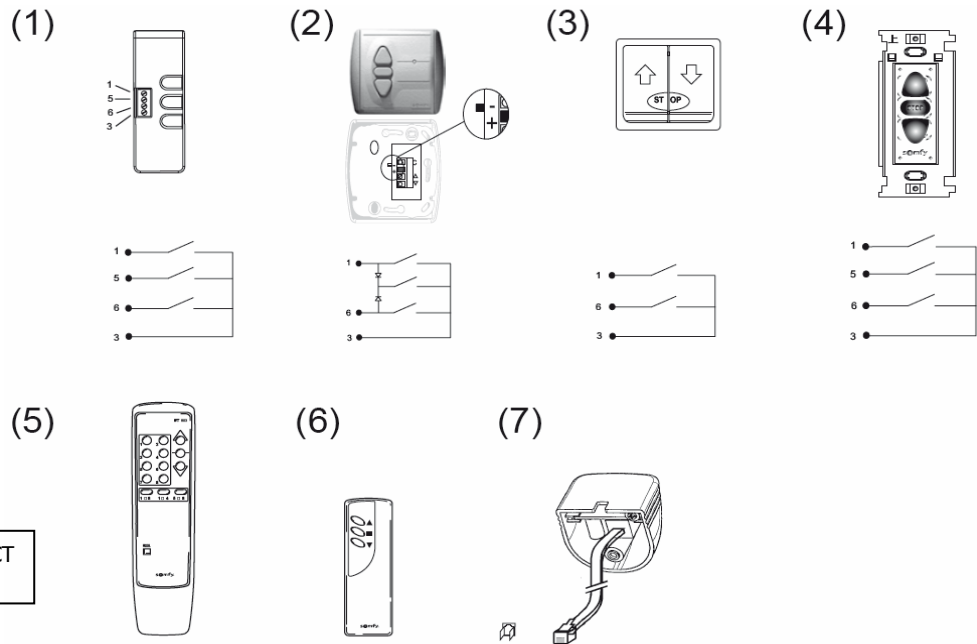

No parallel wiring of Glydea 35 DCT
without DCT splitter

B) Assign / Deleting a channel for IR8 transmitter

Note: by factory default, the motor is paired to ALL channels on the transmitter. To designate one channel to a particular blind, the user must first delete unwanted channels.

- To enter in programming mode: Press on the transmitter prog. Button until the curtain jogs.
- To program one channel: Press on key 1 and next on the key of the channel to program (1 to 8) or channel group until the curtain jogs.
- To exit programming mode: Press on the transmitter prog. Button until the curtain jogs.

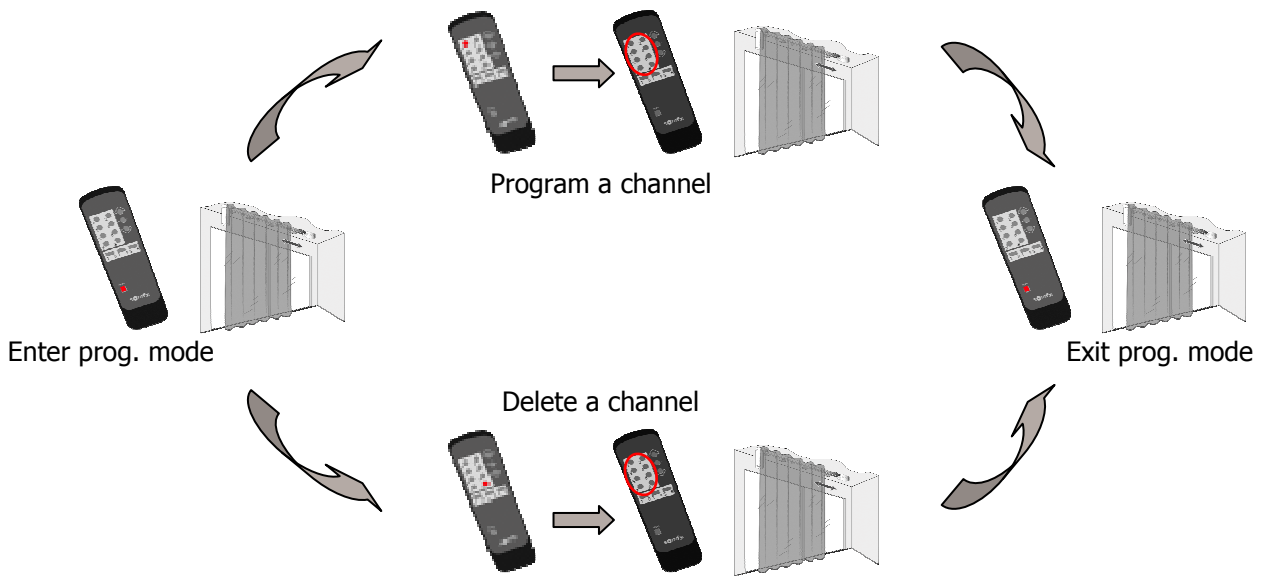

Glydea™ 35 DCT

Programming Instructions 2/2

C) Setting with 3 Normally open dry contact switches or IR control point Switch on the power supply.

C1. Modifying the motor rotation direction

Move the curtain away from the end limit.

- 1) Press the OPEN (UP), STOP and CLOSE (DOWN) buttons simultaneously until the curtain jogs.
- 2) Press the STOP button, until the curtain jogs to reverse the rotation direction.

C2. Dry contact ergonomics setting: Standard or 2 buttons sequencing

- 1) Press and hold the OPEN (UP), STOP and CLOSE (DOWN) buttons simultaneously until the curtain jogs.
- 2) Press the STOP and CLOSE (DOWN) buttons simultaneously until the curtain jogs to change the ergonomics.

C3. Back release setting

Move the curtain to the OPEN (UP) end limit

- 1) Press the STOP and CLOSE (DOWN) buttons simultaneously until the curtain jogs
- 2) Press and hold the CLOSE (DOWN) button to readjust the back release position
- 3) To confirm the new back release position, press and hold the STOP button until the curtain jogs

For accuracy the positioning must be done in one movement. If the position is not satisfactory, go through the all procedure again

To erase the back release position, set it on the hard stop limit

Note: Do set a back release position on thick curtain to warranty the drive shaft release to allow manual operation at open position.

C4. Erasing the memory of the motor.

Press and hold the OPEN (UP), STOP and CLOSE (DOWN) buttons simultaneously until the curtain jogs 3 times.
All the settings are erased.

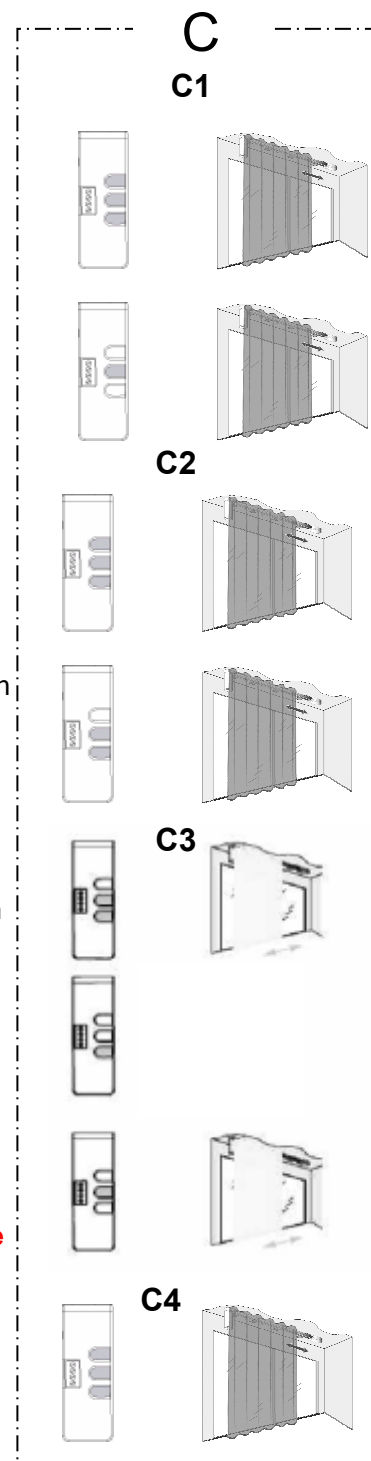

Glydea™ 60e DCT Programming Instructions 1/5

A) Compatible controls And control wiring

- 1) DCT setting tool
- 2) Centralis IB
- 3) 2 NO (Normally Open)
Dry contact switch
- 4) Somfy CS1
- 5) IR8
- 6) IR1
- 7) IR3 & RJ9/RJ12 adapter

(1)

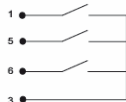
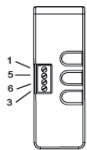

(2)

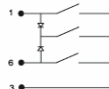
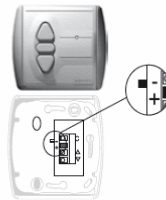

(3)

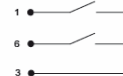
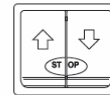

(4)

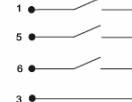
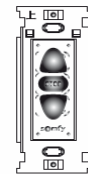

No parallel wiring of Glydea 35
DCT without DCT splitter

(5)



(6)



(7)

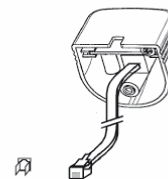

B) Setting with 3 NO (Normally Open) dry contact switches or IR control point Switch on the power supply.

After the first OPEN or CLOSE command, the curtain will
run at reduced speed to one end, then the other to set
the End Stops..

B1. Modifying the motor rotation direction

Move the curtain away from the end limits.

- 1) Press the OPEN (UP), STOP and CLOSE (DOWN) buttons simultaneously until the curtain jogs.
- 2) Press the STOP button until the curtain jogs to reverse the rotation direction.

(1)



(2)



Glydea™ 60e DCT

Programming Instructions 2/5

B2. End limit re-adjustment

a) OPEN LIMIT

- 1) Press the OPEN (UP) button, to move the curtain to the open limit.
- 2) Press and hold the OPEN (UP), STOP and CLOSE (DOWN) buttons simultaneously until the curtain jogs.
- 3) Press and hold the OPEN (UP) or CLOSE (DOWN) button to move the curtain to the new desired position.
- 4) To confirm the new limit press and hold the STOP button until the curtain jogs.

b) CLOSE LIMIT

- 1) Press the CLOSE (DOWN) button to move the curtain to the close limit.
- 2) Press and hold the OPEN (UP), STOP and CLOSE (DOWN) buttons simultaneously until the curtain jogs.
- 3) Press and hold the OPEN (UP) or CLOSE (DOWN) button to move the curtain to the new desired position.
- 4) To confirm the new limit press and hold the STOP button until the curtain jogs.

Note: Do set an open limit position on thick curtain to warranty the drive shaft release to allow manual operation at open position.

B3. Touch motion sensitivity

- 1) Press and hold the OPEN (UP), STOP and CLOSE (DOWN) buttons simultaneously until the curtain jogs.
- 2) Press the OPEN (UP), and CLOSE (DOWN) buttons simultaneously to switch from no touch motion to low sensitivity to high sensitivity and back to no touch motion.
- 3) Press the STOP button until the curtain jogs to confirm the setting.

B4. Dry contact ergonomics setting: Standard or 2 buttons sequencing

- 1) Press and hold the OPEN (UP), STOP and CLOSE (DOWN) buttons simultaneously until the curtain jogs.
- 2) Press the STOP and CLOSE (DOWN) buttons simultaneously until the curtain jogs to change the ergonomics.

B2

a)



b)



B3



B4



Glydea™ 60e DCT

Programming Instructions 3/5

B5. Speed setting

- 1) Press and hold the OPEN (UP) and STOP buttons simultaneously until the curtain starts to open and close
- 2) Press OPEN (UP) to increase the speed, CLOSE (DOWN) to decrease the speed
- 3) Press the STOP button until the curtain jogs to confirm the setting.

B6. MY position

- 1) Recording MY position.
To set the MY position, move the curtain to the desired position with the OPEN (UP) and CLOSE (DOWN) buttons then press the STOP button until the curtain jogs.
- 2) Delete the MY position
To delete the MY position, move to this position and press the STOP button until the curtain jogs.

B6



B7

B7. Erasing the memory of the motor.

Press and hold the OPEN (UP), STOP and CLOSE (DOWN) buttons simultaneously until the curtain jogs 3 times. All the settings are erased.

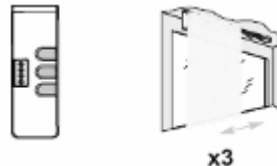

Glydea™ 60e DCT

Programming Instructions 4/5

C) Setting using the Mode and Set motor buttons and a two button NO (Normally Open) dry contact switch.

A Small paper clip is needed to press the Mode and Set buttons.

After the first OPEN or CLOSE command, the curtain will run at reduced speed to one end, then the other to set the End Stops.

C1. Press the M button until the green led switches on to enter in setting mode.

You can exit from the setting mode at any time, by pressing the M button until the LED switches off.

C2. Modifying the motor rotation direction

- 1) Press the S button to reverse the rotation direction. Green LED ON = Open/CCW, Green LED blinking = Open/CW
- 2) Press the M button to confirm the change and go to the next step. The red light is on.

C3. Open End limit re-adjustment

- 1) Press and hold the OPEN (UP) or CLOSE (DOWN) button to move the curtain to the new desired position.
- 2) Press the S button to memorize the open limit, the curtain moves to the close limit. It can be stopped by pressing the stop (MY) button.
- 3) Press the M button to confirm the change and go to the next step. The red light flashes.

Note: Do set an open limit position on thick curtain to warranty the drive shaft release to allow manual operation at open position.

C4. Close End limits re-adjustment

- 1) Press and hold the OPEN (UP) or CLOSE (DOWN) button to move the curtain to the new desired position.
- 2) Press the S button to memorize the close limit, the curtain moves to the open limit. It can be stopped by pressing the stop (MY) button.
- 3) Press the M button to confirm the change and go to the next step. The Yellow LED is on or blinking.

C5. Touch motion sensitivity

- 1) Press the S button to switch from no touch motion (yellow LED is on) to low sensitivity (Yellow LED blinks) to high sensitivity (Yellow LED blinks quicker).
- 2) Press the M button to confirm and go to the next step. The led flashes alternatively from green to red and the curtain starts to open and close.

C6. Speed setting

- 1) Press the S button to switch the speed from 15 cm/s to 17.5 cm/s, to 20 cm/s, to 12.5 cm/s, and back to 15 cm/S
- 2) Press the M button to confirm and go back to direction setting. The green LED is on or blinking.

C7. Erasing the memory of the motor

Push the SET Button until the motor jogs 3 times and the Red LED turns on (12 seconds). It will light for 4 seconds, then the motor will reset.

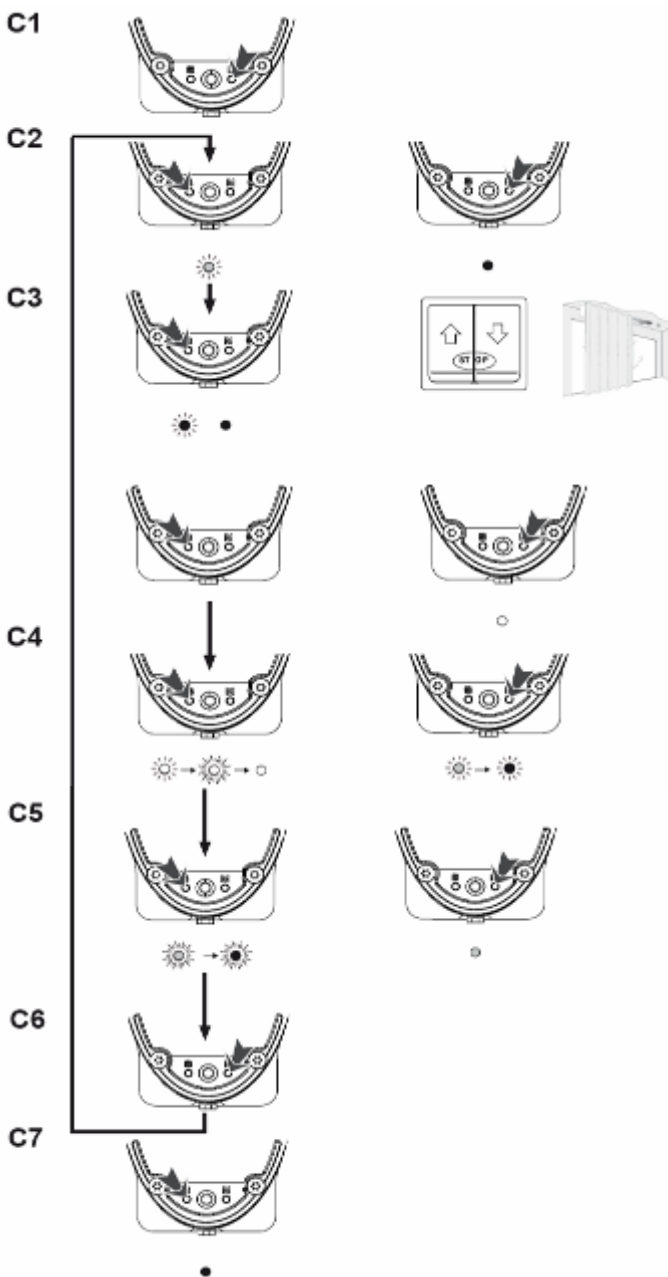

Glydea™ 60e DCT

Programming Instructions 5/5

D Assign/Deleting a channel for IR 8 transmitter

Note : to use a IR transmitter, you need to plug a IR sensor on the RJ 12 motor plug.

D1 Assign a channel

Note : By factory default, the motor is paired to ALL channels on the transmitter.

To designate one channel to a particular blind, the user must first delete unwanted channels (see step DELETE A CHANNEL).

To enter in programming mode: Press on the transmitter prog button until the curtain jogs.

To program one channel : press on key 1 and next on the key of the channel to program (1 to 8) or channel group until the curtain jogs.

To exit programming mode: press on the transmitter prog button until the curtain jogs.

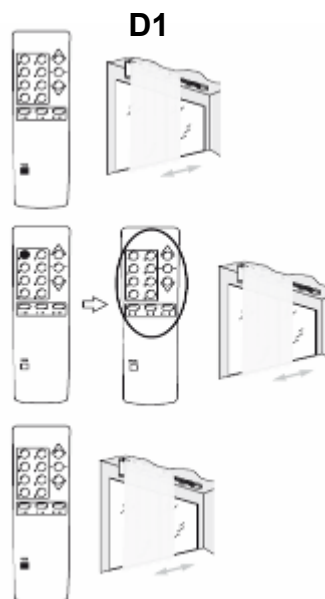

D2

D2 Delete a channel

To enter in programming mode: Press on the transmitter prog button until the curtain jogs.

To erase one channel: press on key 8 and next on the key of the channel to remove (1 to 8) or channel group until the curtain jogs.

To erase all channels: press on key 8 and next on key 1_8 until the motor curtain jogs.

To exit programming mode : press on the transmitter prog button until the curtain jogs.

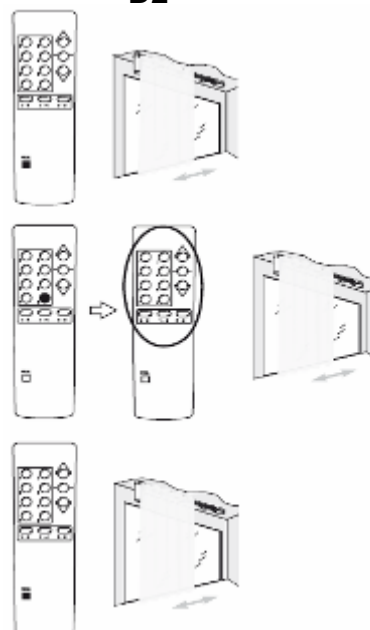

Glydea™ RTS Receiver Programming Instructions 1/6

Compatible controls



OPTIONAL

1) Slide the RTS receiver into the notch (a)

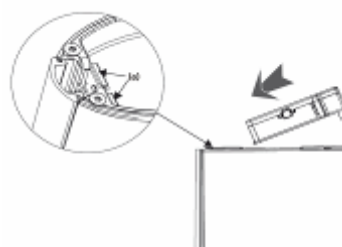

2) Clip the RTS receiver into the plug (b)

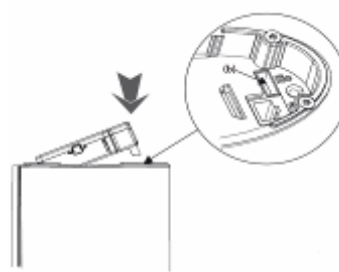

Glydea™ RTS Receiver Programming Instructions 2/6

Programming the RTS control point

Switch on the power supply.

Press the OPEN (UP) and CLOSE (DOWN) buttons simultaneously on the RTS control point: the curtain jogs.

and the control point is preprogrammed in the motor.



GLYDEA™ 60e RTS only

The curtain makes a first run to record the hard stop positions at first command.

Checking the direction of rotation

1) Press the RTS control point OPEN (UP) button:

a) If the curtain opens, the direction of rotation is correct

b) If the curtain closes, the direction of rotation is incorrect: move to the next step.

2) Press the RTS control point MY button until the curtain jogs: the direction of rotation has been modified.

3) Press the RTS control point OPEN (UP) button to check the direction of rotation.

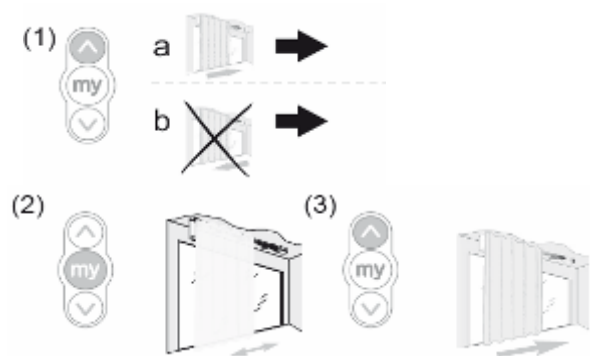

Recording the RTS control point

Press the programming button on the back of the RTS control point until the motor jogs.

The RTS control point address is permanently recorded.

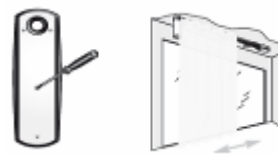

Glydea™ RTS Receiver Programming Instructions 3/6

Back release setting

GLYDEA™ 35 RTS only

Move the curtain to the OPEN end limit.

- 1) Press the MY and CLOSE (DOWN) buttons simultaneously until the curtain jogs.
- 2) Press the CLOSE (DOWN) button to readjust the back release position.
- 3) To confirm the new back release position, press and hold the MY button until the curtain jogs.

For accuracy the positioning must be done in one movement.

If the position is not satisfactory, go through the all procedure again.

- 4) To erase the back release position, set it on the hard stop limit.

Note: Do set a back release position on thick curtain to warranty the drive shaft release to allow manual operation at open position.



MY position

GLYDEA™ 60e RTS only

- 1) Recording MY position.

To set the MY position, move the curtain to the desired position with the UP and DOWN buttons then press the MY button until the curtain jogs.

- 2) Delete the MY position

To delete the MY position, move to this position and press the MY button until the curtain jogs.

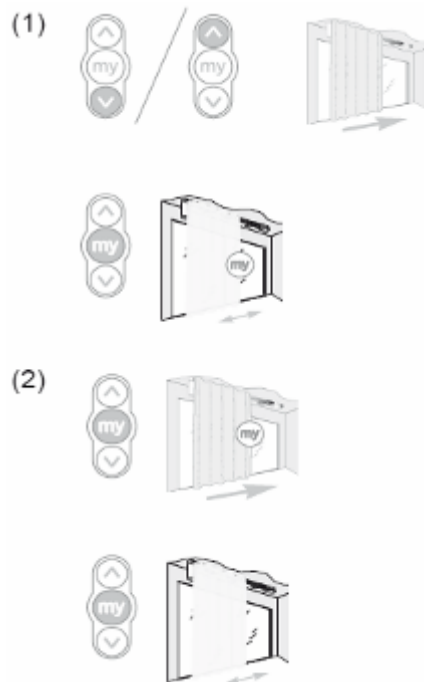

Glydea™ RTS Receiver Programming Instructions 4/6

End limit re-adjustment GLYDEA™ 60e RTS only

a) OPEN (UP) LIMIT

- 1) Press the OPEN (UP) button, to move the curtain to the limit to be readjusted.
- 2) Press and hold the OPEN (UP) and CLOSE (DOWN) buttons simultaneously until the curtain jogs.
- 3) Press and hold the OPEN (UP) or CLOSE (DOWN) button to move the curtain to the new desired position.
- 4) To confirm the new limit press and hold the MY button until the curtain jogs.

b) CLOSE LIMIT

- 1) Press the CLOSE (DOWN) button to move the curtain to the limit to be readjusted.
- 2) Press and hold the OPEN (UP) and CLOSE (DOWN) buttons simultaneously until the curtain jogs.
- 3) Press and hold the OPEN (UP) or CLOSE (DOWN) button to move the curtain to the new desired position.
- 4) To confirm the new limit press and hold the MY button until the curtain jogs.

Note: Do set an open limit position on thick curtain to warranty the drive shaft release to allow manual operation at open position.

Modifying the motor rotation direction

Glydea™ 35 RTS and Glydea™ 60e RTS

Move the curtain away from the end limits.

- 1) Press the OPEN (UP) and CLOSE (DOWN) buttons simultaneously until the curtain jogs.
- 2) Press the MY button until the curtain jogs to reverse the rotation direction.

Dry contact ergonomics setting

Glydea™ 35 RTS and Glydea™ 60e RTS

- 1) Press the OPEN (UP) and CLOSE (DOWN) buttons simultaneously until the curtain jogs.
- 2) Press the MY and CLOSE (DOWN) buttons simultaneously until the curtain jogs to change the ergonomics.

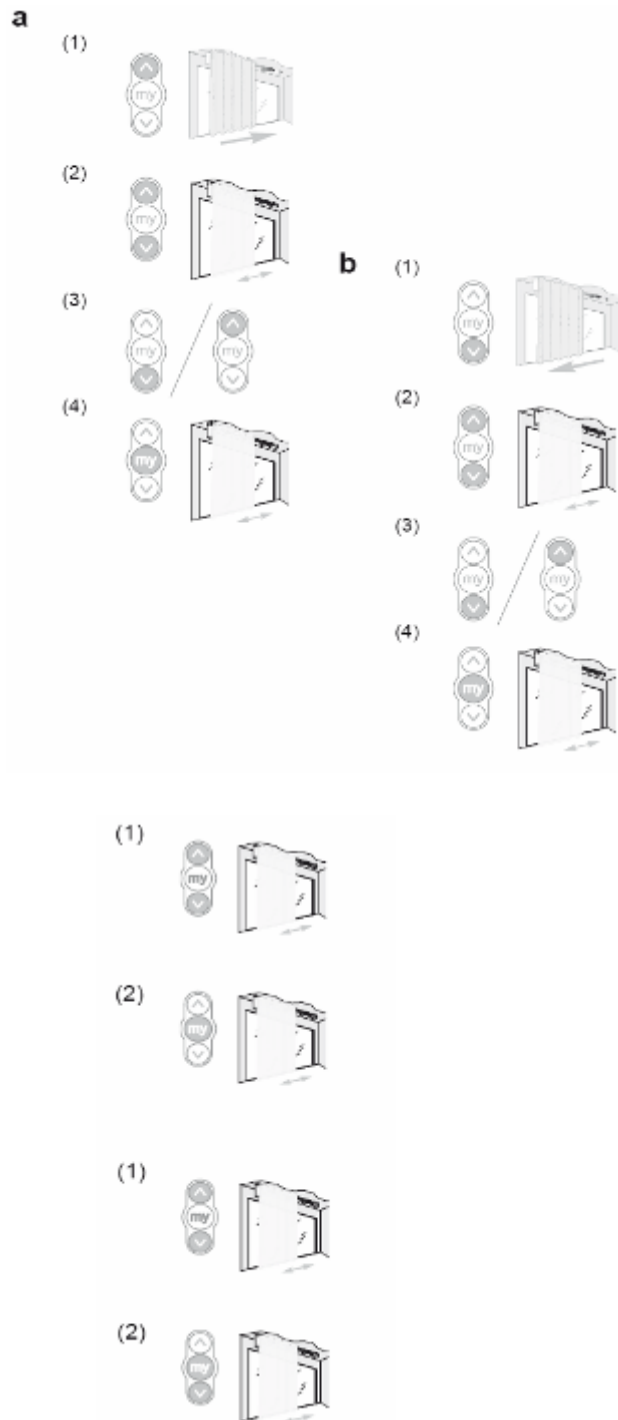

Glydea™ RTS Receiver Programming Instructions 5/6

Touch motion sensitivity GLYDEA™ 60e RTS only

- 1) Press and hold the OPEN (UP) and CLOSE (DOWN) buttons simultaneously until the curtains jogs.
- 2) Press the OPEN (UP) and CLOSE (DOWN) buttons simultaneously until the curtain jogs to switch from no touch motion to low sensitivity; to high sensitivity and back to no touch motion.
- 3) Press the STOP button until the curtain jogs to confirm the setting.

Speed setting GLYDEA™ 60e RTS ONLY

- 1) Press and hold the OPEN (UP) and STOP buttons simultaneously until the curtain starts to open and close
- 2) Press OPEN (UP) to increase the speed, CLOSE (DOWN) to decrease the speed
- 3) Press the STOP button until the curtain jogs to confirm the setting.

Adding/Deleting RTS control points Glydea™ 35 RTS and Glydea™ 60e RTS

Find an RTS control point programmed in the motor.

Press and hold the RTS programmed control point (A) PROG button or the receiver PROG button until the curtain jogs: the motor is in programming mode.

Quickly press the RTS control point (B) PROG button to add or delete: the curtain jogs and the RTS control point is programmed or deleted from the motor.



Glydea™ RTS Receiver Programming Instructions 6/6

Adding/Deleting RTS sensors

Find an RTS control point programmed in the motor.

Press and hold the RTS programmed control point (A) PROG button or the receiver PROG button until the curtain jogs; the motor is in programming mode.

Quickly press the RTS sensor (C) PROG button to add or delete: the curtain jogs and the RTS sensor is programmed or deleted from the motor.

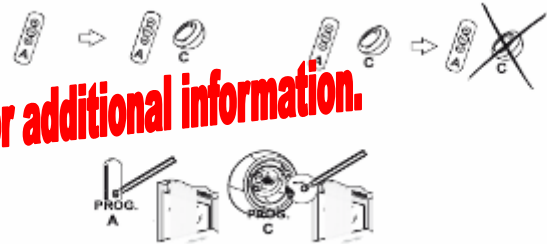

Coming Soon. Contact Somfy for additional information.

Erasing the transmitters of the motor

To delete all the transmitters programmed, press and hold the receiver prog button until the curtain jogs twice.
All the transmitters are deleted.

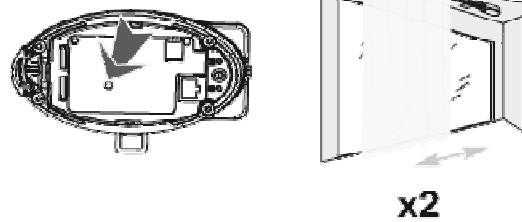

Erasing the memory of the motor

To reset the motor, press the receiver prog button until the curtain jogs 3 times.
All the settings are erased.

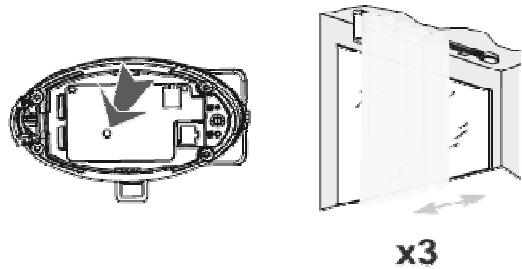

Glydea™ Dry Contact & Glydea RTS Setting Sum Up

	Default Values	Dry contacts setting			RTS setting			Comments
		Enter	Set	Confirm and Exit	Enter	Set	Confirm and Exit	
Direction change	Open CCW	Not at end limits Open+Stop+Close 4s <i>1 jog</i>		Stop 2s to change & exit <i>1 jog</i>	In Temporary mode Not at end limits Open+Close 4s <i>1 jog</i>	Open and Close operational	Stop 2s to change direction	Not at end limits for Glydea 60e because conflict with Limit setting.
Back release	No Back release set	at open limit Stop+Close 4s <i>1 jog</i>	Open or close to position curtain	Stop 2s <i>1 jog</i>	at open limit Stop+Close 4s	Open or close to position curtain	Stop 2s to change & exit <i>1 jog</i>	
Open Limit setting	No end limits set	at open limits Open+Stop+Close 4s <i>1 jog</i>	Open or close to position curtain	Stop 2s <i>1 jog</i>	at open limits Open+Close 4s <i>1 jog</i>	Open or close to position curtain	Stop 2s <i>1 jog</i>	Limit management mode is erased if setting is done at hard Stop
Close limit setting	No end limits set	at close limits Open+Stop+Close 4s <i>1 jog</i>	Open or close to position curtain	Stop 2s <i>1 jog</i>	at close limits Open+Close 4s <i>1 jog</i>	Open or close to position curtain	Stop 2s <i>1 jog</i>	Limit mahagement mode is erased if setting is done at hard Stop
Dry contact ergonomics	Standard	Open+Stop+Close 4s <i>1 jog</i>		Stop+Close 2s to change and exit <i>1 jog</i>	Open+Close 4s <i>1 jog</i>		Stop+Close 2s to change and exit <i>1 jog</i>	
Speed setting	15 cm/s (fo a 6 m trach 35 KG)	Open+stop 4s <i>1 jog</i>	Open to increase speed, Close to decrease speed	Stop 2s <i>1 jog</i>	Open+stop 4s <i>1 jog</i>	Open to increase speed, Close to decrease speed	Stop 2s <i>1 jog</i>	Touch motion function should be active in setting mode to test
Touch Motion	No touch Motion active	Open+Stop+Close 4s <i>1 jog</i>	Open+Close 2s to switch to different sensitivity (loop)	Stop 2s <i>1 jog</i>	Open+Close 4s <i>1 jog</i>	Open+Close 2s to switch to different sensitivity (loop) <i>1 jog</i>	Stop 2s <i>1 jog</i>	
Exit setting mode any time		Open+Stop+Close less than 2s			Open+Stop+Close less than 2s			
Fractory reset		Open+Stop+Close 12s <i>3 jogs</i>			Receiver prog. buton 12s <i>3 jogs</i>			

www.somfysystems.com

Somfy Systems, Inc.
North America Headquarters
121 Herrod Blvd.
Dayton, NJ 08810
(P) 800 22 SOMFY
(P) 609 395 1300
(F) 609 395 1776

Florida
6100 Broken Sound Pkwy
Northwest Suite 14
Boca Raton, FL 33487
(P) 877 227 6639
(P) 561 995 8376
(F) 561 995 7502

California
15291 Barranca Pkwy
Irvine, CA 92618
(P) 877 727 6639
(F) 949 727 3775

Somfy ULC
Somfy Canada
6315 Shawson Drive Unit 1
Mississauga, Ontario L5T1J2
(P) 800 667 6639
(P) 905 564 6446
(F) 905 564 2679